



# HM-TP22-3AQF/W-M20W

## Handheld Thermal Camera

HIKMICRO M20W handheld thermography camera is specially designed for professional inspections of large objects where a wider FOV captures more of the scene in one picture. It's equipped with a 256 × 192 resolution thermal detector, 50° x 37.2° fixed focus lens, and an 8MP resolution visual camera. The high resolution 3.5-inch touch screen displays crisp, clear images and streamlines camera operations. Imaging modes include thermal, visual, picture in a picture of the optical and thermal view, and fusion of both channels. The M20W quickly identifies potential faults and quantifies the impact with accurate temperature measurement, provides detailed documentation to complete your inspections efficiently.

### Key Features

- High sensitivity thermal module with 256 × 192 resolution
- Supports multiple palettes
- High quality optical module with 8 MP resolution
- Bi-spectrum image fusion, picture-in-picture preview
- Wide temperature measurement range: -20 to 550°C
- High temperature measurement accuracy: Max. ( $\pm 2^{\circ}\text{C}/3.6^{\circ}\text{F}$ ,  $\pm 2\%$ ), for ambient temperature 15°C to 35°C (59°F to 95°F) and object temperature above 0°C (32°F)
- High-calibre 640 × 480 resolution 3.5" LCD touch display
- Long-distance laser light supplement for thermography targets
- LED light supplement makes the device a torch in required scenarios
- Supports 1x, 2x, 4x and 8x digital continuous zoom
- Support remote album access, download and quick report with APP.

## Specification

| THERMAL MODE               |   |
|----------------------------|---|
| DETECTOR TYPE              | Vanadium Oxide Uncooled Focal Plane Array                     |
| IR RESOLUTION              | 256 × 192 (49,152 pixels)                                     |
| DETECTOR PITCH             | 12 μm   |
| SPECTRAL RANGE             | 8 μm to 14 μm   |
| NETD                       | < 40 mk (@25°C, F# = 1.0)                                     |
| FOV (FIELD OF VIEW)        | 50° (H) × 37.2° (V)   |
| IMAGE FREQUENCY            | 25 Hz   |
| FOCAL LENGTH               | 3.6 mm  |
| FOCUS                      | Fixed   |
| MIN. FOCUSING DISTANCE     | 0.5 m   |
| IFOV (SPATIAL RESOLUTION)  | 3.33 mrad   |
| APERTURE                   | F1.0  |
| OPTICAL MODE               |   |
| BUILT-IN VISUAL CAMERA     | 3264 × 2448 (8 MP)  |
| FOCUS                      | Fixed   |
| FOV (FIELD OF VIEW)        | 65° (H) × 51° (V)   |
| PICTURE RESOLUTION         | 3264 × 2448 (8MP)   |
| VIDEO RESOLUTION           | 1600 × 1200   |
| IMAGE DISPLAY              |   |
| DISPLAY                    | Display 640 × 480 Resolution, 3.5" LCD Touch Screen           |
| SCREEN BRIGHTNESS          | Manual  |
| DIGITAL ZOOM               | Continuous zoom 1x, 2x, 4x, 8x                                |
| COLOR PALETTES             | White Hot, Black Hot, Rainbow, Ironbow, Red Hot, Fusion, Rain |
| IMAGE MODES                | Thermal/Optical/Fusion/PIP                                    |
| PIP                        | Thermal Picture in Optical Picture                            |
| FUSION                     | Thermal Picture and Optical Picture Combined                  |
| LEVEL/ SPAN                | Auto/Manual   |
| MINIMUM TEMP SPAN (MANUAL) | 2°C (3.6°F)   |
| MEASUREMENT AND ANALYSIS   |   |
| OBJECT TEMPERATURE RANGE   | -20°C to 550°C (-4°F to 1022°F)                               |

|  |   |
|--|---|
| ACCURACY                                     | Max. ( $\pm 2^{\circ}\text{C}/3.6^{\circ}\text{F}$ , $\pm 2\%$ ), for ambient temperature $15^{\circ}\text{C}$ to $35^{\circ}\text{C}$ ( $59^{\circ}\text{F}$ to $95^{\circ}\text{F}$ ) and object temperature above $0^{\circ}\text{C}$ ( $32^{\circ}\text{F}$ ) |
| MEASUREMENT PRESETS                          | Center Spot, Hot Spot, Cold Spot, Off   |
| USER-DEFINED MEASUREMENT POINTS              | 10 points   |
| USER-DEFINED MEASUREMENT LINES               | 1 line with max./min./avg. temperature  |
| USER-DEFINED MEASUREMENT AREAS               | 3 areas with max./min./avg. temperature   |
| HIGH TEMPERATURE ALARM                       | Audible Warning   |
| COLOR ALARM (ISOTHERM)                       | Above/Below/Interval/Insulation   |
| FOCUS-MODE PALETTES                          | Above/Below/Interval  |
| ON-CAMERA EMISSIVITY CORRECTION              | Variable from 0.01 to 1.0 or selected from the materials list   |
| ON-CAMERA REFLECTED TEMPERATURE COMPENSATION | Automatic, based on the input of the reflected temperature  |
| ON-CAMERA TRANSMISSION CORRECTION            | Automatic, based on the inputs for distance and humidity  |
| <b>STORAGE</b>                               |   |
| STORAGE MEDIA                                | Default Storage: Removable SD Card (16 GB);<br>Max. Storage Capacity: 128 GB  |
| IMAGE STORAGE CAPACITY                       | 60,000 Images   |
| IMAGE FILE FORMAT                            | Radiometric image with Measurement Data Included  |
| VOICE NOTE                                   | Max. 60 Seconds   |
| TEXT NOTE                                    | Max. 200 Characters   |
| VIDEO STORAGE CAPACITY                       | 60 Hours  |
| VIDEO FILE FORMAT                            | Standard MP4 non-radiometric video  |
| <b>POWER SYSTEM</b>                          |   |
| POWER SUPPLY                                 | 12 VDC/1.5 A, 5 VDC/2A (Charging via USB)   |
| POWER CONSUMPTION                            | 4.6 W   |
| BATTERY TYPE                                 | Dismountable and Rechargeable Li-ion Battery  |
| BATTERY OPERATING TIME                       | 6 Hours Continuous Running  |
| BATTERY CHARGING TIME                        | 4 hours to full charge  |
| BATTERY CHARGING SYSTEM                      | Two-bay battery charger or in-imager charging, fast charging  |
| AC OPERATION                                 | AC operation with included power supply (100 VAC to 240 VAC, 50/60 Hz)  |
| <b>GENERAL</b>                               |   |
| WI-FI  | 802.11 b/g/n (2.4 GHz and 5 GHz)  |

|                               |   |
|-------------------------------|---|
| BLUETOOTH                     | Bluetooth 4.2   |
| USB INTERFACE                 | USB Type-C  |
| SD CARD INTERFACE             | Micro SD card slot  |
| LED LIGHT (TORCH)             | Yes   |
| LASER POINTER                 | Yes   |
| LASER TYPE                    | Class II, Wavelength: 635 nm; Power: < 1 mW   |
| PROTECTION LEVEL              | IP54  |
| DROP TEST HEIGHT              | 2 m (6.56 ft)   |
| WARRANTY                      | 3 years for full product, 10 years for detector, and 2 years for battery  |
| RECOMMENDED CALIBRATION CYCLE | 1 year (assumes normal operation and normal aging)  |
| SAFETY                        | IEC 61010-1: Overvoltage category II, Pollution Degree 2  |
| ELECTROMAGNETIC COMPATIBILITY | EN 55032: 2015+A11: 2020<br>EN 50130-4: 2011+A1: 2014<br>EN 61000-3-3: 2013<br>EN IEC 61000-3-2: 2019+A1: 2021  |
| AUSTRALIAN RCM                | EN 55032: 2015+A11: 2020<br>EN IEC 61000-3-2: 2019+A1: 2021<br>EN 61000-3-3: 2013+A1: 2019<br>EN 301 489-1 V2.2.3<br>EN 301 489-3 V2.1.1<br>EN 301 489-17 V3.2.4<br>EN 300 328-V2.2.2<br>EN 301 440-V2.1.1<br>EN 301 893-V2.1.1<br>EN 62479: 2010 |
| US FCC                        | CFR 47, Part 15 Subpart C   |
| ROHS COMPLIANT                | Yes   |
| VIBRATION                     | 0.03 g2/Hz (3.8 g), 2.5 g IEC 60068-2-6   |
| SHOCK                         | 25 g, IEC 68-2-29   |
| WORKING TEMPERATURE RANGE     | -10°C to 50°C (14°F to 122°F)   |
| STORAGE TEMPERATURE RANGE     | -20°C to 70°C (-4°F to 158°F)   |
| RELATIVE HUMIDITY             | < 95% non-condensing  |
| WEIGHT                        | Approx. 660 g (1.46 lb)   |
| DIMENSION                     | 244 mm × 100 mm × 104 mm (9.61" × 3.94" × 4.09")  |
| TRIPOD MOUNTING               | UNC ¼"-20   |
| MENU LANGUAGE                 | 21 Languages  |

|                 |   |
|-----------------|---|
|                 | English, German, French, Spanish (Spain), Portuguese (Portugal), Italian, Czech, Slovak, Polish, Hungarian, Romanian, Dutch, Danish, Norwegian, Finnish, Swedish, Russian, Turkish, Japanese, Korean, Chinese (Traditional) |
| <b>SOFTWARE</b> |   |
| PC SOFTWARE     | HIKMICRO Analyzer   |
| APP             | HIKMICRO Viewer App   |
| CAST SCREEN     | UVC Alarm Client  |

Please note that product specifications are subject to change without notice. Please check <https://www.hikmicrotech.com> for the latest changes.

## Ordering Model

**HM-TP22-3AQF/W-M20W**

## Dimension

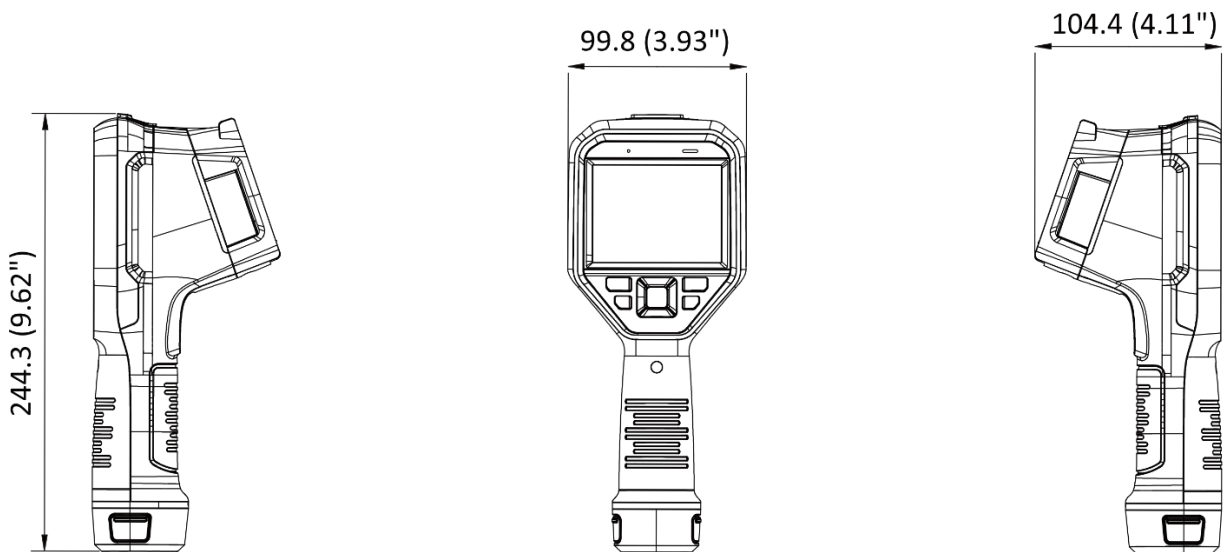

Unit: mm (Inch)

## Packing List

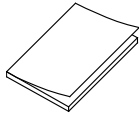

QSG (× 1)

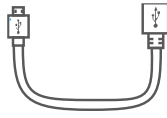

USB 2.0 A to USB Type-C  
Cable (× 1)



Power Supply for  
Battery Charger (× 1)

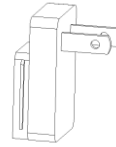

International Use  
Plugs (US/EU/UK/AU)  
for Power Supply

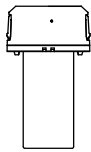

Battery (× 2)

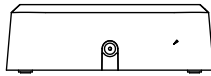

Two-bay Battery Charger (×  
1)

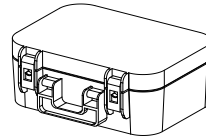

Hard Carrying Case (×  
1)



Wrist Strap (× 1)

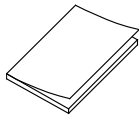

Calibration Certificate  
(× 1)

COMPLIANCE NOTICE: The thermal series products might be subject to export controls in various countries or regions, including without limitation, the United States, European Union, United Kingdom and/or other member countries of the Wassenaar Arrangement. Please consult your professional legal or compliance expert or local government authorities for any necessary export license requirements if you intend to transfer, export, re-export the thermal series products between different countries.

